

BESSEY Spann- und Schneidtechnik

Zubehör- und Ersatzteilliste 2023/2024

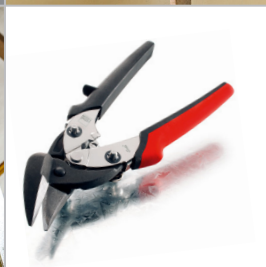

Einfach besser.

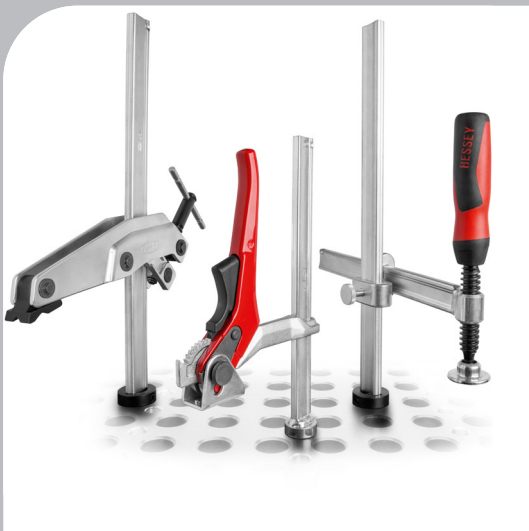

Seit dem 1. Juni 2022
gilt ein Teuerungszuschlag
von 4,6 %

Preise gültig
ab 01.02.2023

4-7 Temperguss-Schraubzwingen



TG / TPN
TGK / TKPN
TGNT

8-11 Ganzstahl-Schraubzwingen



GZ / GS
G...Z
GU25-12-6ZK
GMZ

12-13 Hebelzwingen



GH / GSH
GHS / G...H

14-15 Hochleistungs-zwingen



SLM / SGM / SGL
SG...M / STBM
STBS / STBVC
SGU / STBU
GSL / GSM

16 Variable Schraubzwingen



SLV / GSV

17 Greifarmzwingen



GRA...12

17 Schnellspanner



STC-VH / STC-HH
STC-HV / STC-HA
STC-IHH / STC-IHA
TW..A-STC
TW..VAD / TWVAD

18-20 Spannelemente



TWV / TW
TWM28
TW28GRS
WNS-SET-MFT

21 Maschinentisch-spanner



BAS
BSN
SGHS

22 Korpuszwingen



KRE / KREV
KR / KRV / K

23 Korpusspanner



KS

23 Flächenspanner



FK

23 Getriebezwingen GearKlamp



GK

24 Einhandzwingen



EHZ / EZS / EZ

25 Sparrenzwingen



SPZ

26 Gripzangen



GRZ
GRZRO

26 KliKlamp



KLI

27 Schraubspanner und Winkelspanner



S10 / WS

27 Tischzwingen



EZR / GTR

28 Bandspanner



BAN

29 Kantenzwingen und Plattenträger



EKT
KT5-1
KF / KFP

29 Plattenspanner



PS

30-32 Türfutter- und Fenstermontagewerkzeuge

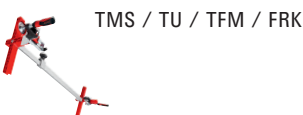

TMS / TU / TFM / FRK

TAN / TB / TL



33 Decken- und Montagestütze



STE / ST

34 Hebelübersetzte Scheren



35 Normalblechscheren



36 Blechknabber und Klingen-Klappmesser



Die BESSEY Produktentwicklung behält sich technische Änderungen vor. Für Druckfehler keine Haftung.

Sämtliche Preisangaben sind unverbindlich empfohlene Richtpreise ohne MwSt.



Temperguss-Schraubzwingen

passend für Serie TG und TPN

	Unterteil kpl. mit 2-Komponenten-Kunststoffgriff		2-Komponenten-Kunststoffgriff inkl. wechselbarer Druckplatte aus Qualitätsstahl mit Schutzkappe			Unterteil kpl. mit Holzgriff		Holzgriff inkl. wechselbarer Druckplatte aus Qualitätsstahl mit Schutzkappe		
	Ausladung mm	für Schiene mm	Länge x Ø mm	Kopf Ø mm	Trapezgewinde mm	Ausladung mm	für Schiene mm	Länge x Ø mm	Kopf Ø mm	Trapezgewinde mm
TG10 / TG...B5										
Bestell-Nr.	-		-			-		-		
Preis										
TG12 / TG...B6										
Bestell-Nr.	-		-			-		-		
Preis										
TG 16 TG...B8 TPN 16 TPN...B8			110 x 30	10	14 x 4					
Bestell-Nr.	-		3101179			-		-		
Preis			11,74 EUR							
TG 20 TG...S10 TPN 20 TPN...S10			110 x 30	12	16 x 4	100	27 x 7	112 x 30	12	16 x 4
Bestell-Nr.	-		3101182			3101413		3101386		
Preis			15,36 EUR			26,89 EUR		12,91 EUR		
TG 25 TG...S12 TPN 25 TPN...S12	120	29 x 9	130 x 34	12	16 x 4	120	29 x 9	125 x 32	12	16 x 4
Bestell-Nr.	3101832		3101186			3101414		3101389		
Preis	37,45 EUR		17,07 EUR			35,64 EUR		14,16 EUR		
TG 30 TG...S14 TPN 30 TPN...S14	140	32 x 10	130 x 34	13	18 x 5	140	32 x 10	140 x 35	13	18 x 5
Bestell-Nr.	3101833		3101187			3101415		3101390		
Preis	41,83 EUR		18,78 EUR			39,48 EUR		16,43 EUR		
TG 40 TG...S17	175	32 x 10	130 x 34	13	18 x 5	175	32 x 10	140 x 35	13	18 x 5
Bestell-Nr.	3101834		3101187			3101416		3101390		
Preis	50,36 EUR		18,78 EUR			48,02 EUR		16,43 EUR		
TPN 40 TPN...S17	175	32 x 10	130 x 34	13	18 x 5	175	32 x 10	140 x 35	13	18 x 5
Bestell-Nr.	3101834		3101187			3101416		3101390		
Preis	50,36 EUR		18,78 EUR			48,02 EUR		16,43 EUR		

Temperguss-Schraubzwingen

passend für Serie TG und TPN

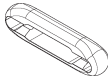
	Druckplatte mit Schutzkappe wechselbar ab Gr. 16	Schutzkappen für Ober- und Unterteil		Schutzkappen- streifen SKS	Knebelaufsatz KA
					
	4 Stück im Beutel	10 Paar im Beutel		2 Stück im Beutel	2 Stück im Beutel
	Ø mm	für Ø mm	für Breite OT mm		nur für Knebelvarianten passend
TG10 / TG...B5	22	22	17		
Bestell-Nr.	3101339	3101391		–	–
Preis	6,51 EUR	13,02 EUR			
TG12 / TG...B6	22	22	19		
Bestell-Nr.	3101339	3101392		–	–
Preis	6,51 EUR	14,08 EUR			
TG 16 TG...B8 TPN 16 TPN...B8	25,5	25,5	23		
Bestell-Nr.	3101180	3101393		–	–
Preis	9,82 EUR	14,16 EUR			
TG 20 TG...S10 TPN 20 TPN...S10	32	32	28		
Bestell-Nr.	3101183	3101394		–	3101194*
Preis	11,20 EUR	15,36 EUR			14,94 EUR
TG 25 TG...S12 TPN 25 TPN...S12	32	32	30		
Bestell-Nr.	3101183	3101395		–	3101194*
Preis	11,20 EUR	15,55 EUR			14,94 EUR
TG 30 TG...S14 TPN 30 TPN...S14	38,5	38,5	32		
Bestell-Nr.	3101188	3101396		–	3101194*
Preis	12,91 EUR	17,07 EUR			14,94 EUR
TG 40 TG...S17	38,5	38,5	32		
Bestell-Nr.	3101188	3101396		–	3101194*
Preis	12,91 EUR	17,07 EUR			14,94 EUR
TPN 40 TPN...S17	38,5				
Bestell-Nr.	3101188	–		SKS20/40	3101194*
Preis	12,91 EUR			8,64 EUR	14,94 EUR

*Lieferung solange Vorrat reicht

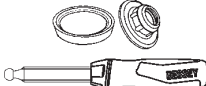
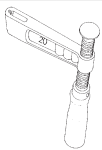
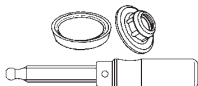

Temperguss-Knechte

passend für Serie TGK und TKPN

	Unterteil kpl. mit 2-Komponenten-Kunststoffgriff		2-Komponenten-Kunststoffgriff inkl. wechselbarer Druckplatte aus Qualitätsstahl mit Schutzkappe			Unterteil kpl. mit Holzgriff		Holzgriff inkl. wechselbarer Druckplatte aus Qualitätsstahl mit Schutzkappe		
										
	Ausladung mm	für Schiene mm	Länge x Ø mm	Kopf Ø mm	Trapezgewinde mm	Ausladung mm	für Schiene mm	Länge x Ø mm	Kopf Ø mm	Trapezgewinde mm
TGK TKPN	120	35 x 11	130 x 34	13	18 x 5	120	35 x 11	140 x 35	13	18 x 5
Bestell-Nr.	3101838		3101187			3101417		3101390		
Preis	40,65 EUR		18,78 EUR			38,52 EUR		16,43 EUR		

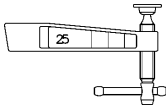

Temperguss-Knechte

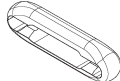
passend für Serie TGK und TKPN

	Knebelgriff		Druckplatte mit Schutzkappe	Schutzkappenstreifen SKS		Knebelaufsatz KA
			 4 Stück im Beutel	 2 Stück im Beutel		 2 Stück im Beutel
	Ausladung mm	für Schiene mm	Ø mm	für Ø mm	für Breite OT mm	nur für Knebelvarianten passend
TGK TKPN			38,5	25,5	23	
Bestell-Nr.	-		3101188	SKS20/40		3101194*
Preis			12,91 EUR	8,64 EUR		14,94 EUR
TGK-K	120	35 x 11	38,5	25,5	23	
Bestell-Nr.	3101418		3101188	SKS20/40		3101194*
Preis	44,28 EUR		12,91 EUR	8,64 EUR		14,94 EUR

Tiefspan-Schraubzwingen

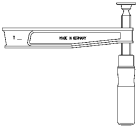
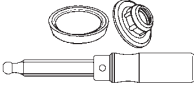
passend für Serie TGNT

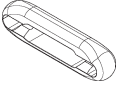
	Unterteil kpl. mit Holzgriff		Holzgriff inkl. wechselbarer Druckplatte aus Qualitätsstahl mit Schutzkappe			Druckplatte mit Schutz- kappe	Knebelaufsatz KA
							
						4 Stück im Beutel	2 Stück im Beutel
	Ausladung mm	für Schiene mm	Länge x Ø mm	Kopf Ø mm	Trapezgewinde mm	Ø mm	nur für Knebel- varianten passend
TGN...T20	200	35 x 11	140 x 35	13	18 x 5	38,5	
Bestell-Nr.	3101419		3101390			3101188	3101194*
Preis	64,87 EUR		16,43 EUR			12,91 EUR	14,94 EUR
TGN...T25	250	40 x 11	140 x 35	13	18 x 5	38,5	
Bestell-Nr.	3101420		3101390			3101188	3101194*
Preis	75,12 EUR		16,43 EUR			12,91 EUR	14,94 EUR
TGN...T30	300	45 x 12	140 x 35	13	18 x 5	38,5	
Bestell-Nr.	3101421		3101390			3101188	3101194*
Preis	93,79 EUR		16,43 EUR			12,91 EUR	14,94 EUR
TGN...T40			140 x 35	13	18 x 5	38,5	
Bestell-Nr.	-		3101390			3101188	3101194*
Preis			16,43 EUR			12,91 EUR	14,94 EUR
TGN...T50			140 x 35	13	18 x 5	38,5	
Bestell-Nr.	-		3101390			3101188	3101194*
Preis			16,43 EUR			12,91 EUR	14,94 EUR

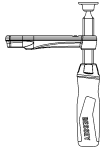
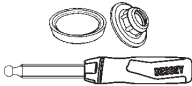
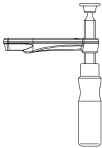
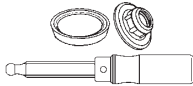

Ganzstahl-Schraubzwingen – neue Version ab 01.07.09

passend für Serie GZ

Gleitbügel kpl. 2-Komponenten- Kunststoffgriff		2-Komponenten-Kunststoffgriff inkl. wechselbarer Druckplatte aus Qualitätsstahl mit Schutzkappe			Gleitbügel kpl. mit Holzgriff		Holzgriff inkl. wechselbarer Druckplatte aus Qualitätsstahl mit Schutzkappe				
											
Aus- ladung mm	für Schiene mm	Länge x Ø mm	Kopf Ø mm	Trapez- gewinde mm	Aus- ladung mm	für Schiene mm	Länge x Ø mm	Kopf Ø mm	Trapez- gewinde mm		
GZ 10 / GZ 12											
Bestell-Nr.		–			–		–				
Preis		–			–		–				
GZ 16		110 x 30			14 x 4		–				
Bestell-Nr.		3101179			–		–				
Preis		11,74 EUR			–		–				
GZ 20 GZ...-10		100	22 x 8,5	110 x 30	12	16 x 4	100	22 x 8,5	112 x 30	12	16 x 4
Bestell-Nr.		3101955		3101182			3101516		3101386		
Preis		22,62 EUR		15,36 EUR			23,26 EUR		12,91 EUR		
GZ 25 GZ...-12		120	24 x 9,5	130 x 34	12	16 x 4	120	24 x 9,5	125 x 32	12	16 x 4
Bestell-Nr.		3101835		3101186			3101517		3101389		
Preis		29,02 EUR		17,07 EUR			27,00 EUR		14,16 EUR		
GZ 30		140	28 x 11	130 x 34	13	18 x 5	140	28 x 11	140 x 35	13	18 x 5
Bestell-Nr.		3101836		3101187			3101518		3101390		
Preis		34,57 EUR		18,78 EUR			32,33 EUR		16,43 EUR		
GZ 40 - GZ 125		120	28 x 11	130 x 34	13	18 x 5	120	28 x 11	140 x 35	13	18 x 5
Bestell-Nr.		3101837		3101187			3101519		3101390		
Preis		37,45 EUR		18,78 EUR			35,42 EUR		16,43 EUR		

Ganzstahl-Schraubzwingen – neue Version ab 01.07.09

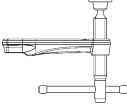
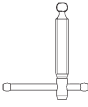
passend für Serie GZ

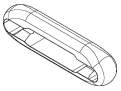
Gleitbügel kpl. mit Knebelgriff		Knebelgriff	2-Komponenten-Kunststoff-Klappgriff inkl. wechselbarer Druckplatte aus Qualitätsstahl mit Schutzkappe			Druckplatte mit Schutzkappe wechselbar ab Gr. 16	Knebelaufsatz KA
							
Ausladung mm	für Schiene mm	Trapezgewinde mm	Länge x Ø mm	Kopf Ø mm	Trapezgewinde mm	Ø mm	nur für Knebelvarianten passend
GZ 10 / GZ 12						22	
Bestell-Nr.	–	–	–			3101339	–
Preis						6,51 EUR	
GZ 16		14 x 4				25,5	
Bestell-Nr.	–	3101795	–			3101180	–
Preis		14,30 EUR				9,82 EUR	
GZ 20 GZ...-10		100 22 x 8,5	16 x 4			32	
Bestell-Nr.	3101441	3101796	–			3101183	3101194*
Preis	30,41 EUR	15,36 EUR				11,20 EUR	14,94 EUR
GZ 25 GZ...-12		120 24 x 9,5	16 x 4	125 x 35	12 16 x 4	32	
Bestell-Nr.	3101444	3101796	3101958			3101183	3101194*
Preis	32,76 EUR	15,36 EUR	20,81 EUR			11,20 EUR	14,94 EUR
GZ 30		140 28 x 11	18 x 5			38,5	
Bestell-Nr.	3101447	3101797	–			3101188	3101194*
Preis	38,09 EUR	17,18 EUR				12,91 EUR	14,94 EUR
GZ 40 - GZ 125		120 28 x 11	18 x 5			38,5	
Bestell-Nr.	3101450	3101797	–			3101188	3101194*
Preis	41,19 EUR	17,18 EUR				12,91 EUR	14,94 EUR

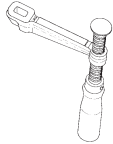
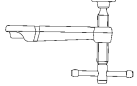
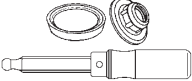
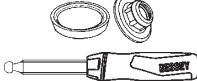

OMEGA-Schraubzwingen und Ganzstahl-Schraubzwingen classiX
sowie Ganzstahl-Schraubzwingen – alte Version bis 30.06.09

passend für Serie GMZ, G...Z, GS

	Gleitbügel kpl. mit Holzgriff		Gleitbügel kpl. mit Knebelgriff		Holzgriff inkl. wechselbarer Druckplatte aus Qualitätsstahl mit Schutzkappe			2-Komponenten-Kunststoffgriff inkl. wechselbarer Druckplatte aus Qualitätsstahl mit Schutzkappe		
	Ausladung mm	für Schiene mm	Ausladung mm	für Schiene mm	Länge x Ø mm	Kopf Ø mm	Trapezgewinde mm	Länge x Ø mm	Kopf Ø mm	Trapezgewinde mm
										
G10Z / G12Z GS10 / GS12										
Bestell-Nr.	-		-		-			-		
Preis	-		-		-			-		
G16Z / GS16								110 x 30	10	14 x 4
Bestell-Nr.	-		-		-			3101179		
Preis	-		-		-			11,74 EUR		
G20Z / G...S10Z GS20 GM 20Z GM...S10Z	100	19,5 x 9,5	100	19,5 x 9,5	112 x 30	12	16 x 4	110 x 30	12	16 x 4
Bestell-Nr.	3101422		3101800		3101386			3101182		
Preis	23,26 EUR		30,94 EUR		12,91 EUR			15,36 EUR		
G25Z / G...S12Z GS25 GM 25Z GM...S12Z GU25-12-6ZK	120	22 x 10,5	120	22 x 10,5	125 x 32	12	16 x 4	130 x 34	12	16 x 4
Bestell-Nr.	3101423		3101801		3101389			3101186		
Preis	27,00 EUR		32,76 EUR		14,16 EUR			17,07 EUR		
G30Z / GS30 GM30Z	140	25 x 12	140	25 x 12	140 x 35	13	18 x 5	130 x 34	13	18 x 5
Bestell-Nr.	3101424		3101802		3101390			3101187		
Preis	32,33 EUR		37,24 EUR		16,43 EUR			18,78 EUR		
G40Z-G60Z GS40-GS60 GM40Z-GM60Z	120	25 x 12	120	25 x 12	140 x 35	13	18 x 5	130 x 34	13	18 x 5
Bestell-Nr.	3101425		3101803		3101390			3101187		
Preis	35,42 EUR		41,19 EUR		16,43 EUR			18,78 EUR		
G80Z-G125Z GS80-GS100 GM80Z-GM125Z	120	27 x 13	120	27 x 13	140 x 35	13	18 x 5	130 x 34	13	18 x 5
Bestell-Nr.	3101426		3101804		3101390			3101187		
Preis	35,42 EUR		41,19 EUR		16,43 EUR			18,78 EUR		

OMEGA-Schraubzwingen und Ganzstahl-Schraubzwingen classiX sowie Ganzstahl-Schraubzwingen – alte Version bis 30.06.09

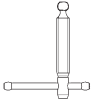
passend für Serie GMZ, G...Z, GS

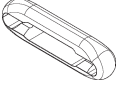
	Knebelgriff	Druckplatte mit Schutzkappe wechselbar ab Gr. 16	Knebelaufsatz KA
		 4 Stück im Beutel	 2 Stück im Beutel
	Trapezgewinde mm	Ø mm	nur für Knebelvarianten passend
G10Z / G12Z GS10 / GS12		22	
Bestell-Nr.	–	3101339	–
Preis		6,51 EUR	
G16Z / GS16	14 x 4	25,5	
Bestell-Nr.	3101795	3101180	–
Preis	14,30 EUR	9,82 EUR	
G20Z/G...-S10Z GS20 GM 20Z GM...S10Z	16 x 4	32	
Bestell-Nr.	3101796	3101183	3101194*
Preis	15,36 EUR	11,20 EUR	14,94 EUR
G25Z/G...-S12Z GS25 GM 25Z GM...-S12Z GU25-12-6ZK	16 x 4	32	
Bestell-Nr.	3101796	3101183	3101194*
Preis	15,36 EUR	11,20 EUR	14,94 EUR
G30Z / GS30 GM30Z	18 x 5	38,5	
Bestell-Nr.	3101797	3101188	3101194*
Preis	17,18 EUR	12,91 EUR	14,94 EUR
G40Z-G60Z GS40-GS60 GM40Z-GM60Z	18 x 5	38,5	
Bestell-Nr.	3101797	3101188	3101194*
Preis	17,18 EUR	12,91 EUR	14,94 EUR
G80Z-G125Z GS80-GS100 GM80Z-GM125Z	18 x 5	38,5	
Bestell-Nr.	3101797	3101188	3101194*
Preis	17,18 EUR	12,91 EUR	14,94 EUR

*Lieferung solange Vorrat reicht

Hebelzwingen – GH – neue Version ab 01.03.10

passend für Serie GH

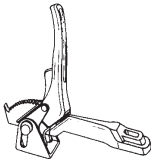
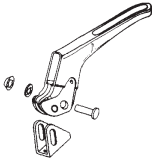
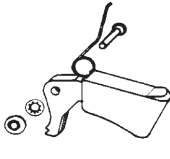
	Gleitbügel kpl.		Hebel mit Druckkappe kpl.	Sperrklinke kpl.
				
				2 Stück im Beutel
	Ausladung mm	für Schiene mm	Bolzen-Ø x l mm	Bolzen-Ø x l mm
GH 12 GH 16				5h11 x 21
Bestell-Nr.	-		-	3101399
Preis				11,20 EUR
GH 20 GH...-10	100	22 x 8,5	10 x 33,5	5h11 x 23
Bestell-Nr.	3101522		3101397	3101400
Preis	61,89 EUR		24,11 EUR	11,95 EUR
GH 25 GH...-12	120	24,5 x 9,5	10 x 33,5	5h11 x 23
Bestell-Nr.	3101523		3101397	3101400
Preis	63,81 EUR		24,11 EUR	11,95 EUR
GH 30	140	28 x 11	12 x 38	5h11 x 26
Bestell-Nr.	3101524		3101398	3101401
Preis	78,00 EUR		33,93 EUR	13,02 EUR
GH 40 - GH 100	120	28 x 11	12 x 38	5h11 x 26
Bestell-Nr.	3101525		3101398	3101401
Preis	88,45 EUR		33,93 EUR	13,02 EUR

Hebelzwingen classiX – GSH sowie Hebelzwingen – GH – alte Version bis 28.02.10

passend für Serie G...H, GSH

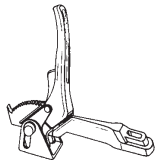
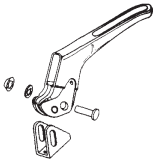
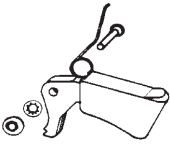
	Gleitbügel kpl.		Hebel mit Druckkappe kpl.	Sperrklinke kpl.
	Ausladung mm	für Schiene mm	Bolzen-Ø x l mm	Bolzen-Ø x l mm
				 2 Stück im Beutel
G12H / G...S6H G16H / G...S8H GSH12 - GSH16				5h11 x 21
Bestell-Nr.	-		-	3101399
Preis				11,20 EUR
G20H / G...S10H GSH20	100	19,5 x 9,5	10 x 33,5	5h11 x 23
Bestell-Nr.	3101333		3101397	3101400
Preis	61,89 EUR		24,11 EUR	11,95 EUR
G25H / G...S12H GSH25 GU-H	120	22 x 10,5	10 x 33,5	5h11 x 23
Bestell-Nr.	3101334		3101397	3101400
Preis	63,81 EUR		24,11 EUR	11,95 EUR
G30H GSH30	140	25 x 12	12 x 38	5h11 x 26
Bestell-Nr.	3101335		3101398	3101401
Preis	78,00 EUR		33,93 EUR	13,02 EUR
G40H - G60H GSH40 - GSH60	120	25 x 12	12 x 38	5h11 x 26
Bestell-Nr.	3101336		3101398	3101401
Preis	88,45 EUR		33,93 EUR	13,02 EUR
G80H - G100H	120	27 x 13	12 x 38	5h11 x 26
Bestell-Nr.	3101337		3101398	3101401
Preis	94,11 EUR		33,93 EUR	13,02 EUR

Hochleistungszwingen – SLM und SGM – **neue Version ab 01.07.08**

	Gleitbügel kpl.		Kombi-Set (Spindel + Spezialdruckplatte + Spannstift)		Knebelaufsatz KA
	Ausladung mm	für Schiene mm	Trapezgewinde mm	Knebel Ø x Länge mm	2 Stück im Beutel
SL...M	120	28 x 11	18 x 5	10 x 120	
Bestell-Nr.	3101521		3100398		3101194*
Preis	59,43 EUR		46,63 EUR		14,94 EUR
SG...M	140	34 x 13	20 x 5	11 x 120	
Bestell-Nr.	3101407		3100399		–
Preis	75,33 EUR		51,22 EUR		



Hochleistungszwingen – SLM/SGM/STBM/STBVC/SGU/STBU/STBS

	Spezial- druckplatte Standard		Spezial- druckplatte mit Riffelung		Spezial- druckplatte mit Prisma		Gewinde- buchse mit Sicherungs- ring	Keil STBS
	Spindel- bohrung mm	Spann- stift mm	Spindel- bohrung mm	Spann- stift mm	Spindel- bohrung mm	Spann- stift mm	Gewinde	2 Stück im Beutel
SLM / SGM STBM / STBVC SGU	12	5 x 20	12	5 x 20	12	5 x 20		
Bestell-Nr.	3100736		3101192		3101193		–	–
Preis	23,69 EUR		26,57 EUR		26,57 EUR			
STBU	12	5 x 20	12	5 x 20	12	5 x 20		
Bestell-Nr.	3100737		3101192		3101193		–	–
Preis	35,64 EUR		26,57 EUR		26,57 EUR			
STBS	12	5 x 20					M 24	
Bestell-Nr.	3100737		–		–		3100579	3101788
Preis	35,64 EUR						18,67 EUR	14,59 EUR

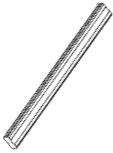
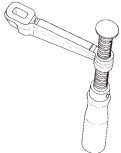
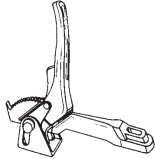
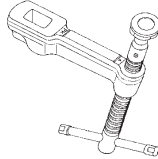

Hochleistungszwingen – STBVC/STB/STBS
Hochleistungszwingen classiX – GSL und GSM
sowie Hochleistungszwingen – SGL und SGM – alte Version bis 30.06.08

	Gleitbügel kpl.		Kombi-Set (Spindel + Spezialdruckplatte + Spannstift)		Knebelaufsatz KA
	Ausladung mm	für Schiene mm	Trapezgewinde mm	Knebel Ø x Länge mm	2 Stück im Beutel
SGL...M / GSL	120	27 x 13	18 x 5	10 x 120	
Bestell-Nr.	3101338		3100398		3101194*
Preis	59,43 EUR		46,63 EUR		14,94 EUR
SG...M	120	30 x 15	20 x 5	11 x 120	
Bestell-Nr.	3101329		3100399		–
Preis	69,57 EUR		51,22 EUR		
SG30M / GSM / SGU	140	30 x 15	20 x 5	11 x 120	
Bestell-Nr.	3101330		3100399		–
Preis	75,33 EUR		51,22 EUR		
SG..T20M	200	30 x 15	20 x 5	11 x 120	
Bestell-Nr.	3101331		3100399		–
Preis	96,14 EUR		51,22 EUR		
STB...M/STBU	175	40 x 20	22 x 5	11 x 180	
Bestell-Nr.	3101332		3100400		–
Preis	98,80 EUR		57,83 EUR		
STBS	200	50 x 25	M24	18 x 345	
Bestell-Nr.	3101798		3100401		–
Preis	283,61 EUR		146,18 EUR		
STBVC	100	40 x 20	22 x 5	11 x 180	
Bestell-Nr.	3101882		3100400		–
Preis	78,64 EUR		57,83 EUR		

Variable Schraubzwingen SLV, GSV

	Schiene mit 2 Endsicherungen		Gleitbügel kpl. mit Holzgriff		Gleitbügel kpl. mit Hebelgriff		Gleitbügel kpl. mit Knebelgriff		Knebelaufsatz KA
									
	Spannweite mm	Schiene mm	Ausladung mm	für Schiene mm	Ausladung mm	für Schiene mm	Ausladung mm	für Schiene mm	nur für Knebelvarianten passend
SLV	1000	27 x 13	120	27 x 13	120	27 x 13	120	27 x 13	
Bestell-Nr.	3101731		3101426		3101337		3101338		3101194*
Preis	55,16 EUR		35,42 EUR		94,11 EUR		59,43 EUR		14,94 EUR
SLV	1500	27 x 13	120	27 x 13	120	27 x 13	120	27 x 13	
Bestell-Nr.	3101732		3101426		3101337		3101338		3101194*
Preis	112,46 EUR		35,42 EUR		94,11 EUR		59,43 EUR		14,94 EUR
SLV	2000	27 x 13	120	27 x 13	120	27 x 13	120	27 x 13	
Bestell-Nr.	3101733		3101426		3101337		3101338		3101194*
Preis	168,69 EUR		35,42 EUR		94,11 EUR		59,43 EUR		14,94 EUR

GSV	3000	30 x 15					120	30 x 15	
Bestell-Nr.	3101612		-		-		3101329		-
Preis	253,20 EUR						69,57 EUR		
GSV	3000	30 x 15					140	30 x 15	
Bestell-Nr.	3101612		-		-		3101330		-
Preis	253,20 EUR						75,33 EUR		
GSV	3000	30 x 15					200	30 x 15	
Bestell-Nr.	3101612		-		-		3101331		
Preis	253,20 EUR						96,14 EUR		

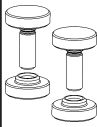
	Spezialdruckplatte Standard		Spezialdruckplatte mit Riffelung		Spezialdruckplatte mit Prisma		Endsicherung
							
	Spindelbohrung mm	Spannstift mm	Spindelbohrung mm	Spannstift mm	Spindelbohrung mm	Spannstift mm	
SLV / GSV	12	5 x 20	12	5 x 20	12	5 x 20	
Bestell-Nr.	3100736		3101192		3101193		3101782
Preis	23,69 EUR		26,57 EUR		26,57 EUR		15,23 EUR

Greifarmzwingen – neue Version ab 01.04.12

	Greifarm kpl.		Spindel kpl.	
	Ausladung mm	für Schiene mm	Trapezgewinde mm	Knebel Ø x l mm
GRA...12	120	28 x 11	18 x 5	8 x 110
Bestell-Nr.	3101590		3100562	
Preis	102,97 EUR		18,14 EUR	

Schnellspanner STC

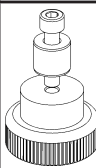
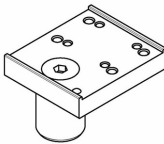
	Spindel-Set kpl.	Für Multifunktions- tische Adapter	Für Schweißtische		Verlängerung	
			Schnellspanner-Adapter		Loch Ø	Verstell- weg
STC-VH20 / STC-HH20 STC-IHH 15		 1 Zylinderschraube DIN 912 M 8 x 35 1 Steckbolzen D20 x 17 1 Rändelmutter M8			Loch Ø	
Bestell-Nr.	3101627	–	TW16A-STC	TW28A-STC		–
Preis	4,59 EUR		25,71 EUR	26,89 EUR		
STC-HV20 / STC-HA20 STC-IHA 15						
Bestell-Nr.	3101627	–	–	–		–
Preis	4,59 EUR					
STC-VH50 / STC-HH 50 STC-IHH 25			16	28		
Bestell-Nr.	3101589	STC-SET-T20	TW16A-STC	TW28A-STC		–
Preis	5,01 EUR	12,38 EUR	25,71 EUR	26,89 EUR		
STC-HH 70			16	28		
Bestell-Nr.	3101588	STC-SET-T20	TW16A-STC	TW28A-STC		–
Preis	5,23 EUR	12,38 EUR	25,71 EUR	26,89 EUR		
TW16A-STC TW16VAD / TWVAD					16	15-200
Bestell-Nr.	–	–	–	–	TW16X	
Preis					21,02 EUR	
TW28A-STC TW28VAD / TWVAD					28	15-300
Bestell-Nr.	–	–	–	–	TW28X	
Preis					28,28 EUR	

Spannelemente mit variabler Ausladung TWV

	Schiene		Kreuzhalter kpl.	Gleitbügel kpl. mit 2-Komponenten-Kunststoffgriff		Gleitbügel kpl. mit Knebelgriff		Gleitbügel kpl. mit Hebelgriff		Werkbank-Adapter
	Spannweite mm	Schiene mm	für Schiene mm	Ausladung mm	für Schiene mm	Ausladung mm	für Schiene mm	Ausladung mm	für Schiene mm	passend für
TWV16	200	22 x 8,5	22 x 8,5	30-150	22 x 8,5	30-150	22 x 8,5	60-150	22 x 8,5	19 mm/3/4"
Bestell-Nr.	3101740		3101744	3101741		3101742		3101743		TW16AW19
Preis	36,06 EUR		31,80 EUR	33,82 EUR		31,58 EUR		46,31 EUR		14,19 EUR
TWV16	200	22 x 8,5	22 x 8,5	30-150	22 x 8,5	30-150	22 x 8,5	60-150	22 x 8,5	20 mm/13/16"
Bestell-Nr.	3101740		3101744	3101741		3101742		3101743		TW16AW20
Preis	36,06 EUR		31,80 EUR	33,82 EUR		31,58 EUR		46,31 EUR		14,80 EUR
TWV16	200	22 x 8,5	22 x 8,5	30-150	22 x 8,5	30-150	22 x 8,5	60-150	22 x 8,5	25,4 mm/1"
Bestell-Nr.	3101740		3101744	3101741		3101742		3101743		TW16AW25*
Preis	36,06 EUR		31,80 EUR	33,82 EUR		31,58 EUR		46,31 EUR		16,86 EUR
TWV16	200	22 x 8,5	22 x 8,5	30-150	22 x 8,5	30-150	22 x 8,5	60-150	22 x 8,5	30 mm/1 3/16"
Bestell-Nr.	3101740		3101744	3101741		3101742		3101743		TW16AW30
Preis	36,06 EUR		31,80 EUR	33,82 EUR		31,58 EUR		46,31 EUR		18,35 EUR
TWV28	300	28 x 11	28 x 11	40-175	28 x 11	40-175	28 x 11	110-175	28 x 11	–
Bestell-Nr.	3101706		3101710	3101707		3101708		3101709		
Preis	42,57 EUR		37,24 EUR	39,80 EUR		36,92 EUR		54,52 EUR		



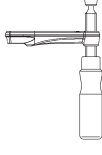
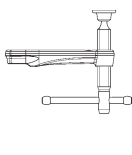
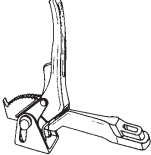
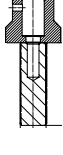

Waagrecht-Niederzugspanner für Multifunktions-tische WNS-SET-MFT

Bankhaken für Multifunktions-tische	
 <p>4 Bankhaken 4 Rändelmutter</p>	
Bolzen-Ø mm	
WNS-SET-MFT	20
Bestell-Nr.	BH-MFT
Preis	13,76 EUR

Spannelemente mit fixer Ausladung TW

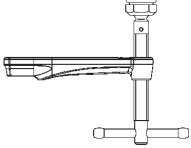
	Schiene		Gleitbügel kpl. mit Holzgriff		Gleitbügel kpl. mit Knebelgriff		Gleitbügel kpl. mit Hebelgriff		Werkbank-Adapter
									
	Spannweite mm	Schiene mm	Ausladung mm	für Schiene mm	Ausladung mm	für Schiene mm	Ausladung mm	für Schiene mm	passend für
TW16	200	22 x 8,5	100	22 x 8,5	100	22 x 8,5	100	22 x 8,5	19 mm/3/4"
Bestell-Nr.	3101740		3101516		3101441		3101522		TW16AW19
Preis	36,06 EUR		23,26 EUR		30,41 EUR		61,89 EUR		14,19 EUR
TW16	200	22 x 8,5	100	22 x 8,5	100	22 x 8,5	100	22 x 8,5	20 mm/13/16"
Bestell-Nr.	3101740		3101516		3101441		3101522		TW16AW20
Preis	36,06 EUR		23,26 EUR		30,41 EUR		61,89 EUR		14,80 EUR
TW16	200	22 x 8,5	100	22 x 8,5	100	22 x 8,5	100	22 x 8,5	25,4 mm/1"
Bestell-Nr.	3101740		3101516		3101441		3101522		TW16AW25*
Preis	36,06 EUR		23,26 EUR		30,41 EUR		61,89 EUR		16,86 EUR
TW16	200	22 x 8,5	100	22 x 8,5	100	22 x 8,5	100	22 x 8,5	30 mm/1 3/16"
Bestell-Nr.	3101740		3101516		3101441		3101522		TW16AW30
Preis	36,06 EUR		23,26 EUR		30,41 EUR		61,89 EUR		18,35 EUR
TW28	300	28 x 11	120	28 x 11	120	28 x 11	120	28 x 11	–
Bestell-Nr.	3101706		3101519		3101450		3101525		–
Preis	42,57 EUR		35,42 EUR		41,19 EUR		88,45 EUR		
TW28	300	28 x 11	140	28 x 11	140	28 x 11	140	28 x 11	–
Bestell-Nr.	3101706		3101518		3101447		3101524		–
Preis	42,57 EUR		32,33 EUR		38,09 EUR		78,00 EUR		



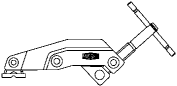
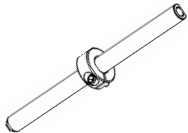

Spannelemente mit Spezialdruckplatte TWM28

	Gleitbügel kpl. mit Knebelgriff und Spezialdruckplatte		Spezialdruckplatte Standard		Spezialdruckplatte mit Riffelung		Spezialdruckplatte mit Prisma	
								
	Ausladung mm	für Schiene mm	Spindelbohrung mm	Spannstift mm	Spindelbohrung mm	Spannstift mm	Spindelbohrung mm	Spannstift mm
TWM28	120	28 x 11	12	5 x 20	12	5 x 20	12	5 x 20
Bestell-Nr.	3101521		3100736		3101192		3101193	
Preis	59,43 EUR		23,69 EUR		26,57 EUR		26,57 EUR	

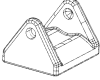

Spannelemente TW28GRS / TWWAD / TWA-STC / TW28AV

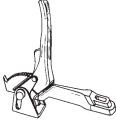
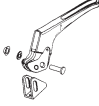
	Schiene		Greifarm kpl.		Verlängerung	
						
	Spannweite mm	Schiene mm	Ausladung mm	für Schiene mm	Loch Ø mm	Verstellweg mm
TW28GRS	300	28 x 11	120	28 x 11		
Bestell-Nr.	3101706		3101590		-	
Preis	42,57 EUR		102,97 EUR			
TWWAD TW16VAD TW16A-STC					16	15-200
Bestell-Nr.	-		-		TW16X	
Preis					21,02 EUR	
TWWAD TW28VAD TW28A-STC TW28AV					28	15-300
Bestell-Nr.	-		-		TW28X	
Preis					28,28 EUR	

Maschinentischspanner BAS, BS, SGHS

	Druckarm	Druckschuh	Spindel	Gleitbügel kpl.		Hebel mit Druckkappe kpl.	Sperrklinke kpl.
							
		4 St. im Beutel	2 St. im Beutel				2 St. im Beutel
				Ausladung mm	für Schiene mm	Bolzen-Ø x l mm	Bolzen-Ø x l mm
BAS...9-4							
Bestell-Nr.	3101428	3101431	3101726	-		-	-
Preis	81,95 EUR	31,80 EUR	51,64 EUR				
BAS...10-6							
Bestell-Nr.	3101429	3101431	3101726	-		-	-
Preis	87,81 EUR	31,80 EUR	51,64 EUR				
BSP...10-6							
Bestell-Nr.	3101430	-	3101726	-		-	-
Preis	82,48 EUR		51,64 EUR				
BS2N / BS3N							5h11 x 26
Bestell-Nr.	-	-	-	-		-	3100747
Preis							20,06 EUR
BS4N							5h11 x 26
Bestell-Nr.	-	-	-	-		-	3100748
Preis							21,02 EUR
BS5N / BS6N SG-HS				140	30 x 15	12 x 38	
Bestell-Nr.	-	-	-	3101432		3101029	-
Preis				102,97 EUR		63,91 EUR	

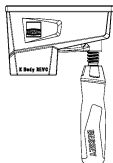
Korpuszwingen KR/KRV/KRE/KREV

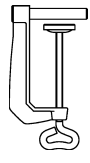
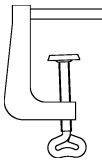
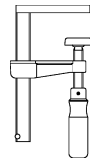
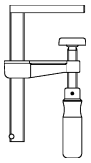
	Unterteil kpl. mit Gleitbügel		Set im Beutel		Tischklemme		Tischklemme		Tischklemme		Tischklemme	
	Ausladung mm	für Schiene mm			Spannweite mm	Ausladung mm	Spannweite mm	Ausladung mm	Spannweite mm	Ausladung mm	Spannweite mm	Ausladung mm
			3 Schutzkappen 2 Auflagen 1 Endsicherung			Ø 8 mm		Ø 8 mm		Ø 8 mm		Ø 8 mm
KR...-2K KRV...-2K KRE...-2K KREV...-2K	95	29 x 9			60	22	60	28	100	50	150	50
Bestell-Nr.	3101774	3101775			TK6		RB269		LM10/5R8		LM15/5R8	
Preis	45,67 EUR	10,56 EUR			4,80 EUR		10,14 EUR		23,26 EUR		24,01 EUR	

Korpuszwingen K/KR/KRV/KRE/KREV

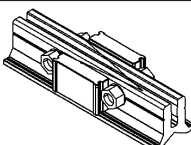
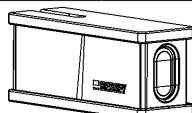
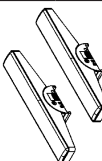
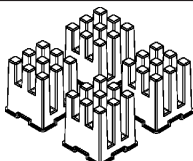
	Verlängerung		Variables Oberteil		Adapter, schwenkbar		Rahmenpressen-Set	
			Ausladung mm	für Schiene mm	Backen- höhe mm	Backen- breite mm		
								
					2 Stück /Packung		4 Stück /Packung	
K...			95	29 x 9				
Bestell-Nr.	KBX20	KRE-VO			-		KP	
Preis	22,51 EUR	24,01 EUR					34,46 EUR	
KR...-2K KRV...-2K KRE...-2K KREV...-2K			95	29 x 9	170	25		
Bestell-Nr.	KBX20	KRE-VO			KR-AS	KP		
Preis	22,51 EUR	24,01 EUR			15,23 EUR	34,46 EUR		

Korpusspanner KS

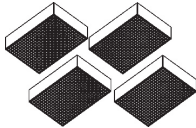
Druckstück	
 <p>4 Stück/Packung</p>	
KS	
Bestell-Nr.	3101845
Preis	36,92 EUR

Flächenspanner FK

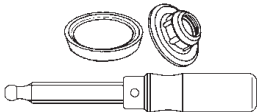
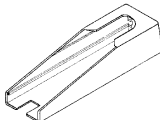
	Spindel kpl. mit Holzgriff	Schutzkappe
		 <p>2 Stück im Beutel</p>
	Trapezgewinde mm	Ausladung mm
FK16-8		80
Bestell-Nr.	-	3101790
Preis		5,55 EUR
FK...-10	16 x 4	100
Bestell-Nr.	3101386	3101789
Preis	12,91 EUR	6,08 EUR

Getriebezwinge GearKlump GK

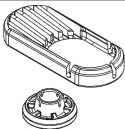
Druckplatte + Schutzkappe im Set	
 <p>5 Paar</p>	
Ø mm	
GK	26
Bestell-Nr.	3101840
Preis	9,28 EUR

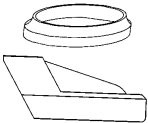
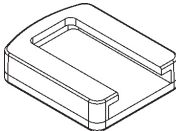

Einhandzwinge EHZ / EZS

	Schutzkappen-Set	Schutzkappen-Set
	 <p>5 Paar</p>	 <p>10 Stück</p>
	Ø mm	mm
EHZ...-2K	32	
Bestell-Nr.	3101402	–
Preis	9,18 EUR	
EZS		40 x 48
Bestell-Nr.	–	3101841
Preis		13,02 EUR

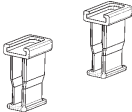

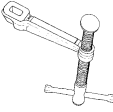
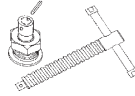
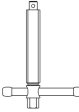
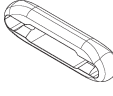

Einhandzwinge EZ

	Schutzkappen-Set	Adapter
	 <p>5 Paar</p>	 <p>1 Paar</p>
EZM		
Bestell-Nr.	3101959	3101962
Preis	8,11 EUR	11,52 EUR
EZL		
Bestell-Nr.	3101960	–
Preis	9,82 EUR	
EZXL		
Bestell-Nr.	3101961	–
Preis	14,51 EUR	

Sparrenzwinge SPZ60K und SPZ80K

	Gleitbügel kpl.	Kombi-Set Spindel + Spezialdruckplatte + Spannstift		Spindel		Knebelaufsatz KA	Druckplatte mit Schutzkappe
		 ohne Sechskant		 mit Sechskant		 2 Stück im Beutel	 4 Stück im Beutel
	für Schiene mm	Trapez- gewinde mm	Knebel Ø x Länge mm	Trapez- gewinde mm	Knebel Ø x Länge mm		
SPZ60K	27 x 13	18 x 5	10 x 120				
Bestell-Nr.	3101338	3100398		-		3101194*	3101188
Preis	59,43 EUR	46,63 EUR				14,94 EUR	12,91 EUR
SPZ80K	30 x 15	20 x 5	11 x 120	20 x 5	11 x 120		
Bestell-Nr.	3101330	3100399		3101815		-	-
Preis	75,33 EUR	51,22 EUR		27,74 EUR			

Sparrenzwinge SPZ80K

	Spezialdruckplatte Standard		Spezialdruckplatte mit Riffelung		Spezialdruckplatte mit Prisma		Schneidring	
								
	Spindel- bohrung mm	Spann- stift mm	Spindel- bohrung mm	Spann- stift mm	Spindel- bohrung mm	Spann- stift mm	Spindel- bohrung mm	Spann- stift mm
SPZ80K	12	5 x 20	12	5 x 20	12	5 x 20	12	5 x 20
Bestell-Nr.	3100736		3101192		3101193		3101219*	
Preis	23,69 EUR		26,57 EUR		26,57 EUR		25,82 EUR	

Gripzangen GRZ

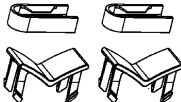
	Schutzkappe für GRZ10 und GRZ20	Schutzkappe für GRZRO
	 4 Stück	 4 Stück
GRZ 10 - GRZ 20		
Bestell-Nr.	3100576	–
Preis	5,34 EUR	
GRZRO		
Bestell-Nr.	–	3101547
Preis		6,62 EUR

KliKlump KLI

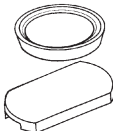
	Schutzkappen für Ober- und Unterteil	
	 10 Paar im Beutel	
	für Ø mm	für Breite OT mm
KLI	25,5	23
Bestell-Nr.	3101393	
Preis	14,16 EUR	

Schraubspanner S10 / Winkelspanner WS

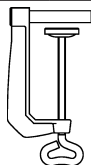
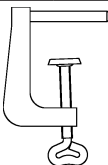
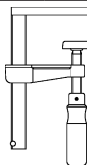
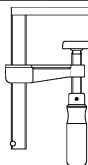
	Tischklemme		Tischklemme		Tischklemme		Tischklemme	
								
	Ø 8 mm		Ø 8 mm		Ø 8 mm		Ø 8 mm	
	Spannweite mm	Ausladung mm	Spannweite mm	Ausladung mm	Spannweite mm	Ausladung mm	Spannweite mm	Ausladung mm
S10-ST / WS 3	60	22	60	28	100	50	150	50
Bestell-Nr.	TK6		RB269		LM10/5R8		LM15/5R8	
Preis	4,80 EUR		10,14 EUR		23,26 EUR		24,01 EUR	

Einhand-Tischzwinge EZR

	Schutzkappen-Set	Adapter
		
	5 Paar	1 Paar
EZR		
Bestell-Nr.	3101959	3101962
Preis	8,11 EUR	11,52 EUR

Ganzstahl-Tischzwinge GTR

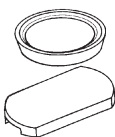
	Schutzkappen für Ober- und Unterteil	
		
	10 Paar im Beutel	
	für Ø mm	für Breite OT mm
GTR	22	17
Bestell-Nr.	3101391	
Preis	13,02 EUR	

Bandspanner BAN

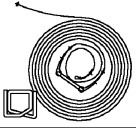
Band Ersatzteil/Verlängerung	
	
BAN 700 / SVH	Band 7100 mm, 2 Spannschnallen
Bestell-Nr.	3100832
Preis	18,67 EUR

Einhand-Kantenzwinge EKT

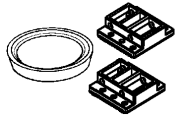
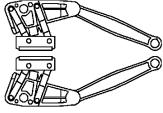
	Ersatzteil-Set	Backen kpl. mit Schubstange
	 <p>3 Paar Druckbacken und 3 Stück Schutzkappen</p>	 <p>2 Paar</p>
EKT55		
Bestell-Nr.	3101403	3100998
Preis	24,11 EUR	27,53 EUR

Kantenzwinge KT

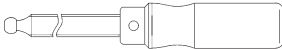
	Spindel kpl.
	
KT5-1	
Bestell-Nr.	3101799
Preis	6,72 EUR

Kantenfix KF und Plattenträger KFP

Druckbacken	
	
1 Paar inkl. Feder	
KF2	
Bestell-Nr.	4102100
Preis	38,84 EUR
KF4	
Bestell-Nr.	4102056
Preis	42,68 EUR
KFP	
Bestell-Nr.	4102057*
Preis	70,00 EUR

* passend für KFP ab 2018 (rote Druckbacken)



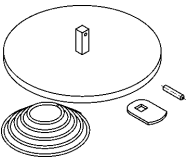
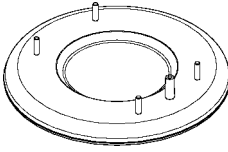
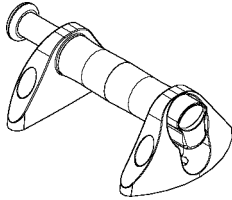

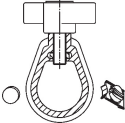

Plattenspanner PS

	Saugspanner	Gummiplatte	Griff
			
	Ø mm	Ø mm	
PS 55	120	-	-
Bestell-Nr.	3101839		
Preis	56,08 EUR		
PS 130		210	
Bestell-Nr.	-	3101685	3101686
Preis		79,92 EUR	85,25 EUR

Türfuttermontagestrebe TMS

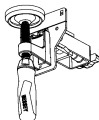
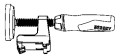
	Klemmstück
	
TMS	
Bestell-Nr.	3100983
Preis	4,91 EUR

Türfutterstrebe TU

	Druckplatte mit Innenrohr und Klemmstück kpl.	Druckplatte mit Außenrohr und Klemmstück kpl.	Spannbügel breit kpl. inkl. Schiebeteil	Ausleger kpl.	Verlängerung	Filzstreifen	TU Tasche
							
		Innenmaß mm				4 Stück im Beutel	
TU		25 x 25					
Bestell-Nr.	3100934	3100935	3101752	3101764	TUX	3101632	3101762
Preis	30,94 EUR	33,93 EUR	28,28 EUR	14,19 EUR	32,01 EUR	7,15 EUR	88,35 EUR

Türfutter-Richtzwinge TFM

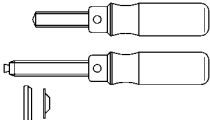
	2 x Spindel mit loser Druckplatte und Schutzkappe
	
TFM	
Bestell-Nr.	3101408
Preis	19,42 EUR

Fenster-Richtzwinge FRK

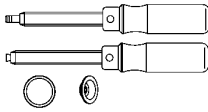
	2 x Spindel mit loser Druckplatte und Schutzkappe	
		
FRK		
Bestell-Nr.	3101409	
Preis	19,42 EUR	

Türensprenger TAN

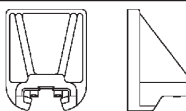
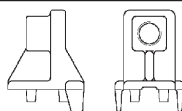
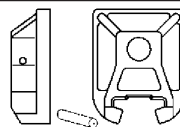
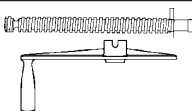
	Druckbacken		Spindelaufnahme	Spannbacken	Spindel-Set TAN
					
	Backenbreite mm	Backenhöhe mm	Trapezgewinde mm		
TAN	75	80	20 x 5		
Bestell-Nr.	3101791*		3101824*	3100919*	3101404*
Preis	44,92 EUR		40,33 EUR	56,08 EUR	40,76 EUR

Türensprenger TB

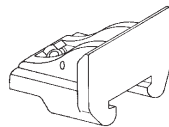
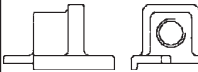
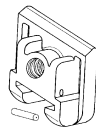
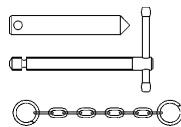
	Druckbacken		Spindelaufnahme	Spannbacken	Spindel-Set TB
					
	Backenbreite mm	Backenhöhe mm	Trapezgewinde mm		
TB	60 (80)	48	18 x 5		
Bestell-Nr.	3101793		3101792	3100920	3101405
Preis	31,80 EUR		31,37 EUR	34,68 EUR	22,51 EUR

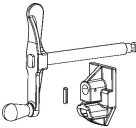
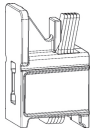

Türenspanner TL

	Spindel-Set TL	Druckbacken kpl.
		
TL		
Bestell-Nr.	3101876	3101877
Preis	19,63 EUR	24,01 EUR



Decken- und Montagesützen STE, ST

	Multifunktions-/ Laserhalterung	Abstützplatte	Deckenstativ	Bodenstativ	Tasche
					
STE					
Bestell-Nr.	STE-LH	STE-SP35	STE-DS	STE-BS	—
Preis	18,57 EUR	15,55 EUR	20,49 EUR	53,24 EUR	—
ST					
Bestell-Nr.	STE-LH	STE-SP35	STE-DS	STE-BS	—
Preis	18,57 EUR	15,55 EUR	20,49 EUR	53,24 EUR	—
STE300 STE370					
Bestell-Nr.	—	—	—	—	STE-BAG
Preis	—	—	—	—	73,62 EUR

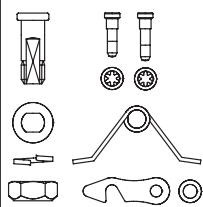
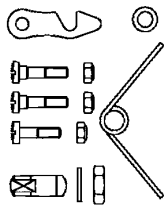
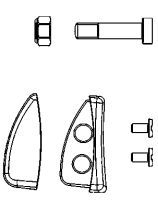

Decken- und Montagstützen STE, ST

	Ersatzkontakt- fläche	Rastnase ST	Sterngriff- schraube
			
STE			
Bestell-Nr.	3101952	–	–
Preis	11,52 EUR		
ST			
Bestell-Nr.	3101952	3101969	–
Preis	11,52 EUR	8,96 EUR	
STE-SP35			
Bestell-Nr.	–	–	3101970
Preis			6,72 EUR

Hebelübersetzte Scheren

	Reparatur-Set 08/22A 27/29/123S	Reparatur-Set 17A-2	Niederhalter komplett 123S	Rolltasche
				 für 3 Scheren
D08 ... D16A D22A D27AH-TiN/L				
Bestell-Nr.	R032	–	–	7002464
Preis	7,26 EUR			9,50 EUR
D16 / D16L / D16S				
Bestell-Nr.	–	–	–	7002464
Preis				9,50 EUR
D27 ... D29 ...				
Bestell-Nr.	R001	–	–	7002464
Preis	7,26 EUR			9,50 EUR
D17A-2/L				
Bestell-Nr.	–	R043	–	7002464
Preis		7,36 EUR		9,50 EUR
D123S				
Bestell-Nr.	R001	–	R042	7002464
Preis	7,26 EUR		14,19 EUR	9,50 EUR

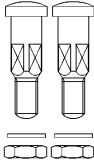
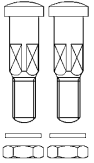
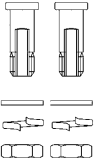

Normalblechscheren

	Verschraubung komplett M6 D8 x 24	Verschraubung komplett M6 D8 x 26	Verschraubung komplett M8 x1 x 22	Rolltasche
	 <p>2 Stück</p>	 <p>2 Stück</p>	 <p>2 Stück</p>	 <p>für 3 Scheren</p>
D101-200 – D101-250 D201-200 – D201-250 D102-225 D202-225 D107-225 – D107-275 D207-225 – D207-275 D114-250 – D114-275 D214-250 – D214-275 D159-200 – D159-250				
Bestell-Nr.	R034	–	–	7002464
Preis	6,19 EUR			9,50 EUR
D102-250 – D102-300 D202-250 – D202-300 D106-250 D106A-250 D107-300 – D107-350 D207-300 – D207-350 D208-275 D209-275 D114-300 D214-300 D159-300 – D159-350				
Bestell-Nr.	–	R035	–	7002464
Preis		6,19 EUR		9,50 EUR
D116-260 – D116-280 D216-260 – D216-280 D216-260-B-SBSK D216-280-B-SBSK D118-300 – D118-350 D218-300 – D218-350 D416-280 D 418-300 – D418-350				
Bestell-Nr.	–	–	R036	7002464
Preis			6,19 EUR	9,50 EUR
D407-275 – D407-300				
Bestell-Nr.	–	–	–	7002464
Preis				9,50 EUR

Blechknabber

		Ersatzmesser	
			
D24			
Bestell-Nr.		D241	
Preis		14,62 EUR	

Klingen-Klappmesser

		Trapezklinge	Hakenklinge	Linoleumklinge
				
		10 Stück	10 Stück	5 Stück
DBKPH DBKWH DBKAH				
Bestell-Nr.		DBK-T	DBK-H	DBK-L
Preis		4,16 EUR	6,72 EUR	7,26 EUR



Einfach besser.



Einfach besser.



Ersatzteilliste DE-EUR 2023 „K“

www.bessey.de

BESSEY Tool GmbH & Co. KG ■ Mühlwiesenstraße 40
74321 Bietigheim-Bissingen, Germany
Fon +49 7142 401-0 ■ Fax Inland: +49 7142 401-451
Fax Export: +49 7142 401-452
E-Mail: tool-info@bessey.de